

SCARPA

SCARPA

COMPOSIZIONE CON MODULI A PARETE

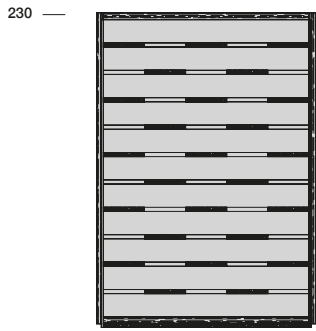

P.35 150

Libreria sistema modulare a parete. Possibilità di composizione con moduli standard o personalizzati. Preventivo su richiesta.
Modular system library. Possibility of composition with standard or customized modules. Quotation on request.

COMPOSIZIONE CON MODULI BIFACCIALI

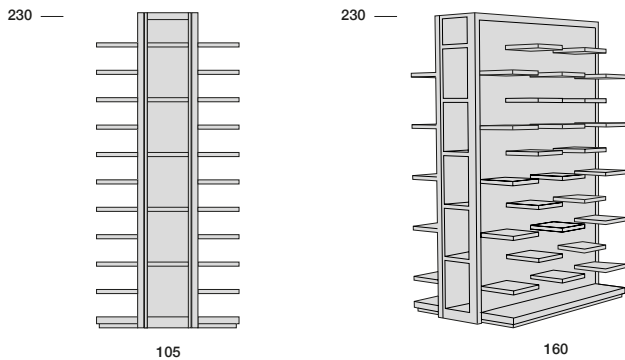

Libreria sistema bifacciale modulare. Possibilità di composizione con moduli bifacciali standard o personalizzati. Preventivo su richiesta.
Modular double-sided library system. Possibility of composition with standard or customized double-sided modules. Quotation on request.

Legenda

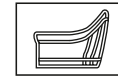

1 - Legno massiccio
- Solid wood

1

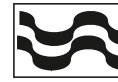

2 - Cinghie elastiche
- Elastic Belts

2

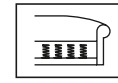

3 - Molle
- Springs

3



4 - Crine
- Vegetable hair

4

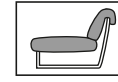

5 - Imbottiture in gomma indeformabile con rivestimento in Dacron.
- Non-deformable foam rubber upholstery with Dacron covering

5

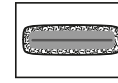

6 - Cuscini gomma indeformabile con rivestimento in Dacron. Possibilità morbidi - medi - rigidi.
- Cushions foam rubber non-deformable with Dacron covering. Possibilities: soft - medium - hard

6



7 - Cuscini piuma
- Feather cushions

7



8 - Legno massiccio scolpito a mano
- Solid hand carved wood

8



9 - Girevole
- Revolving

9



10 - Regolabile in altezza
- Height adjustment

10



11 - Basculante regolabile
- Position adjustment

11



12 - Possibilità letto
- Also for beds

12



13 - Frangia in pelle intrecciata a mano
- Hand-woven leather fringe

13

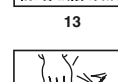

14 - Cucito a mano
- Sewed by hand

14



15 - Curvati in betulla
- Birch shaped wood

15

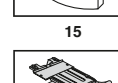

16 - Syncro mechanism

16

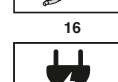

17 - Motore elettrico
- Electric engine

17

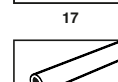

18 - Telaio in acciaio
- Steel frame

18